

SWAY TABLE

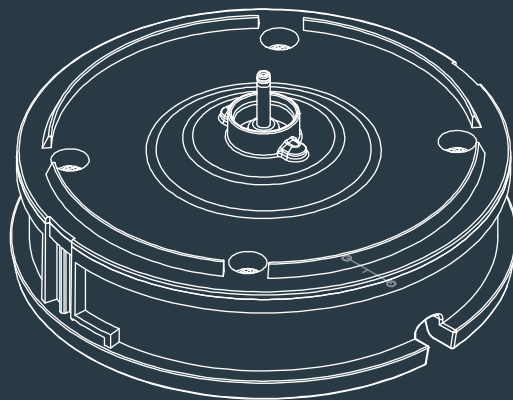

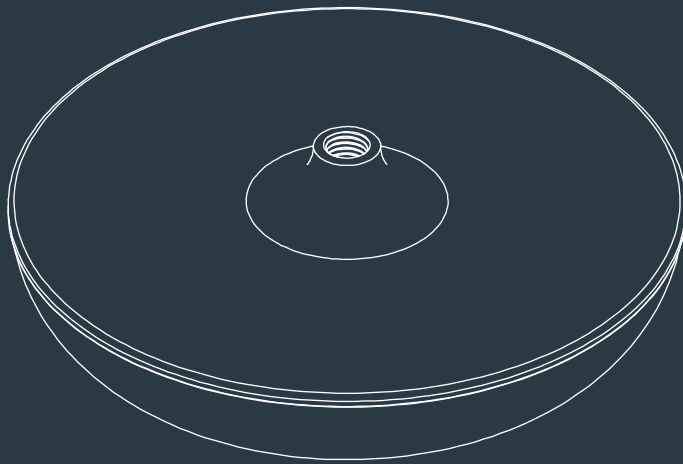

in-lite®

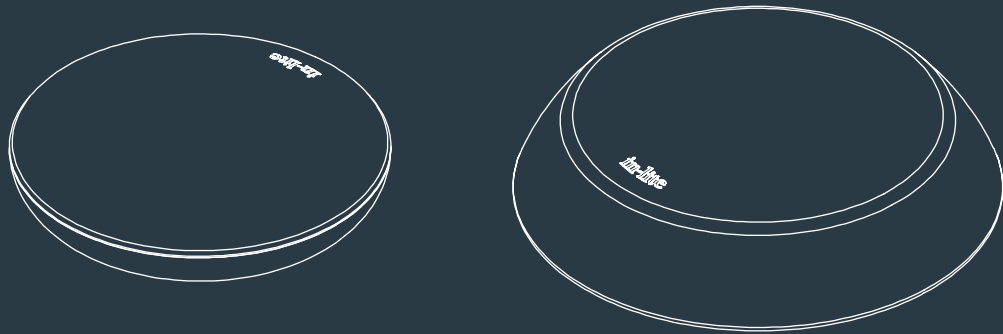
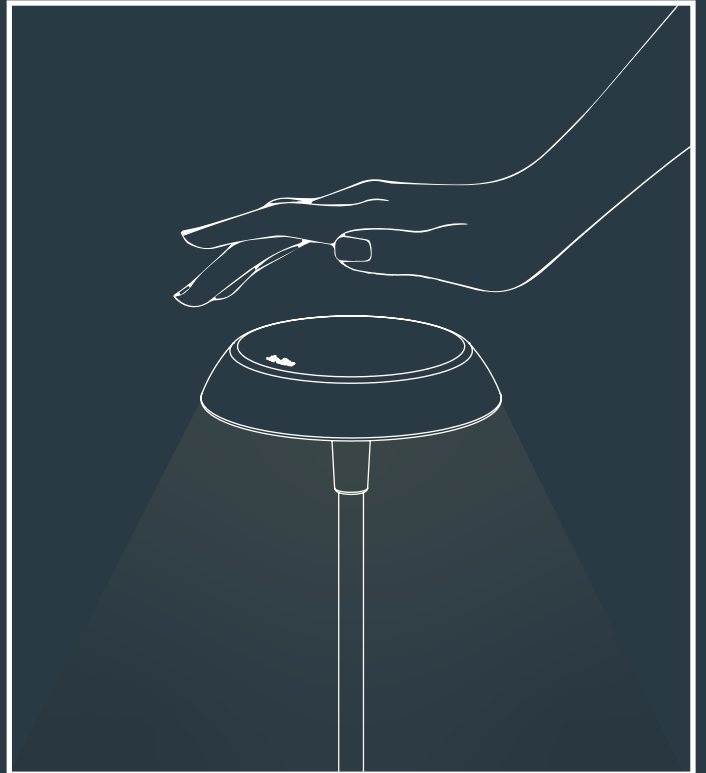
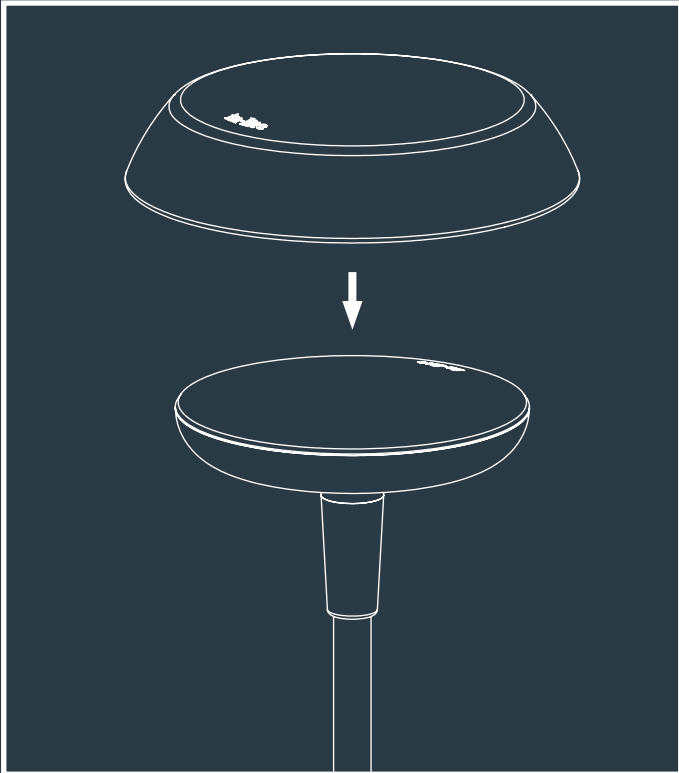
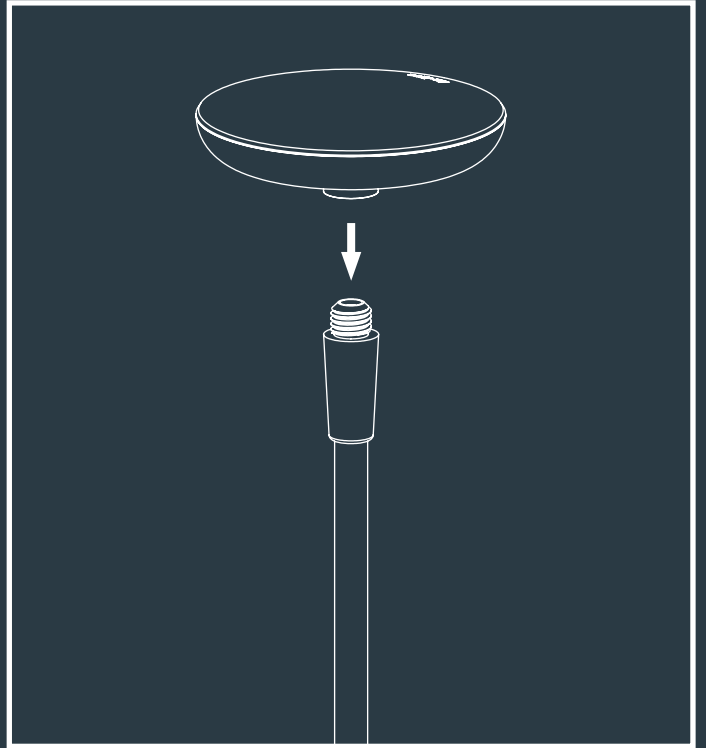
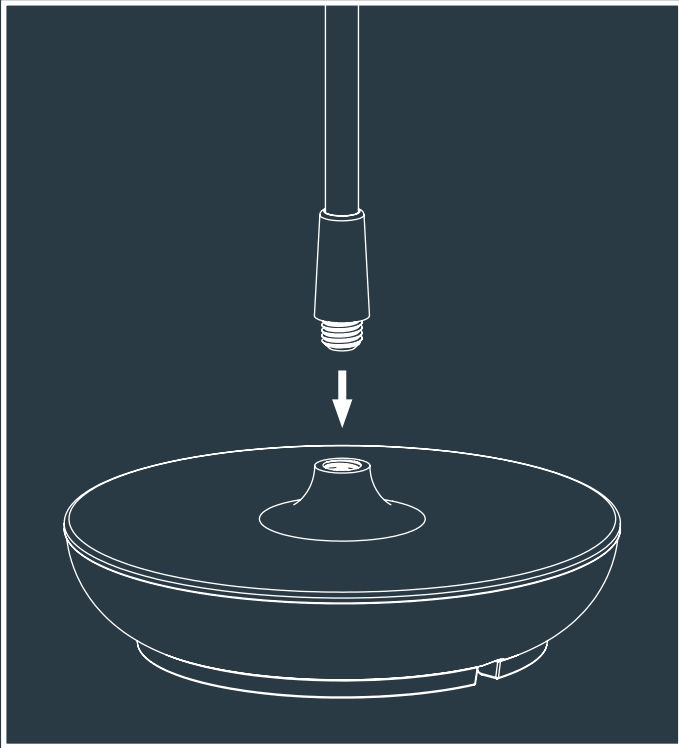
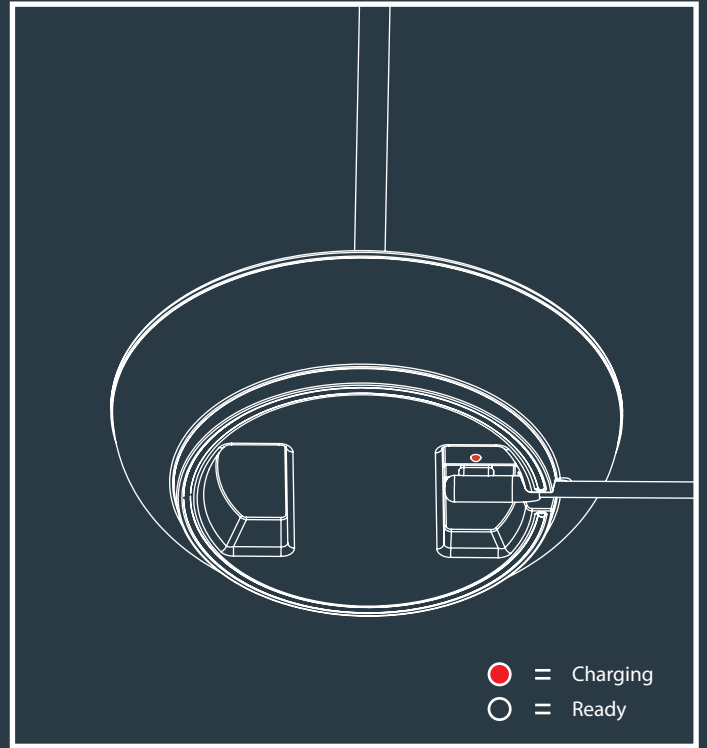
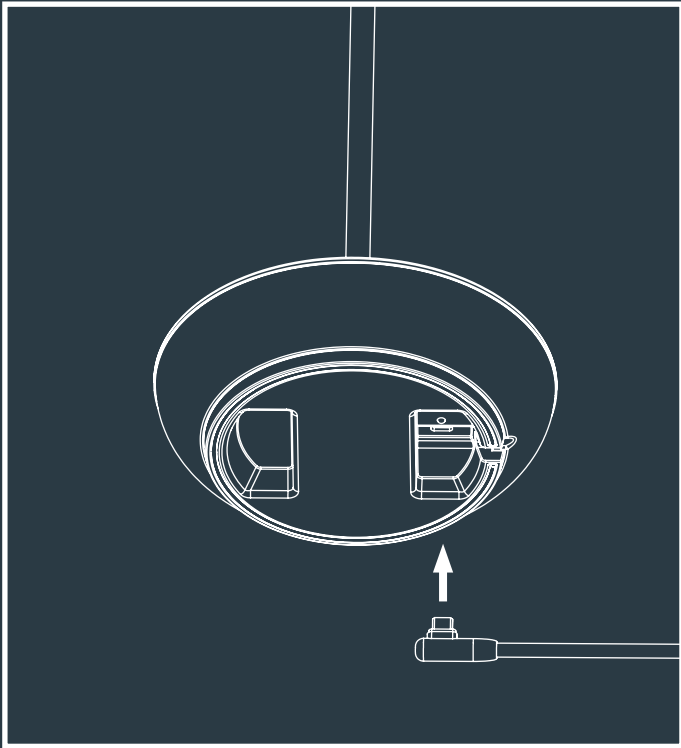

OR

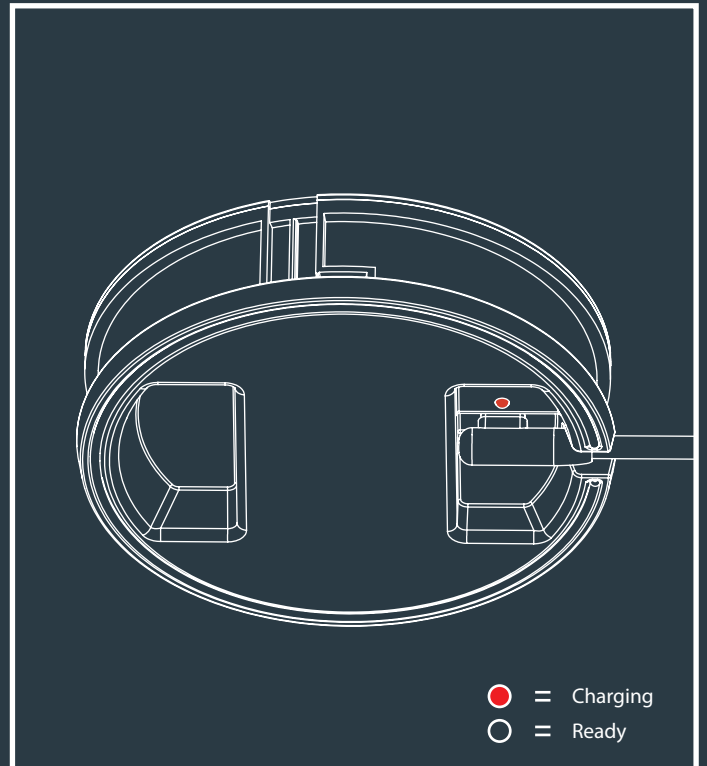
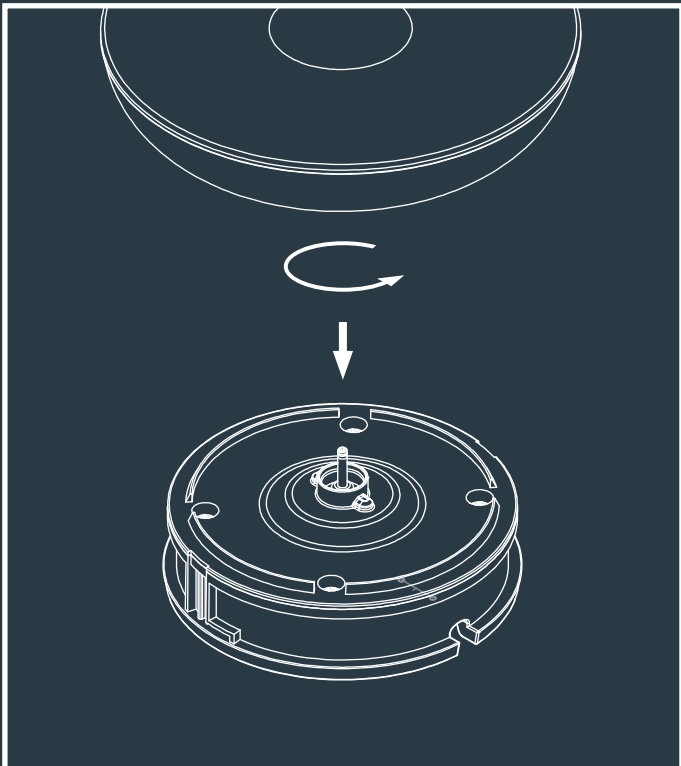

in-lite

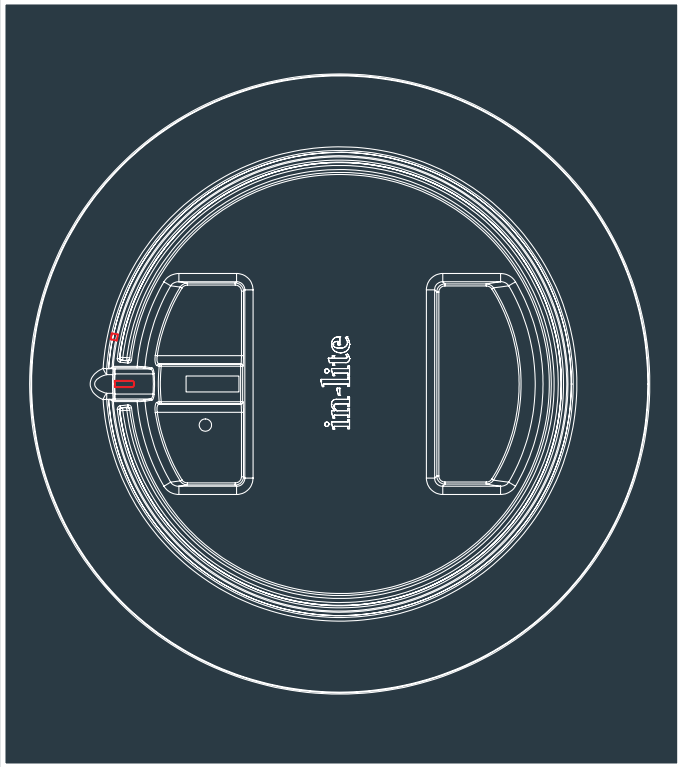
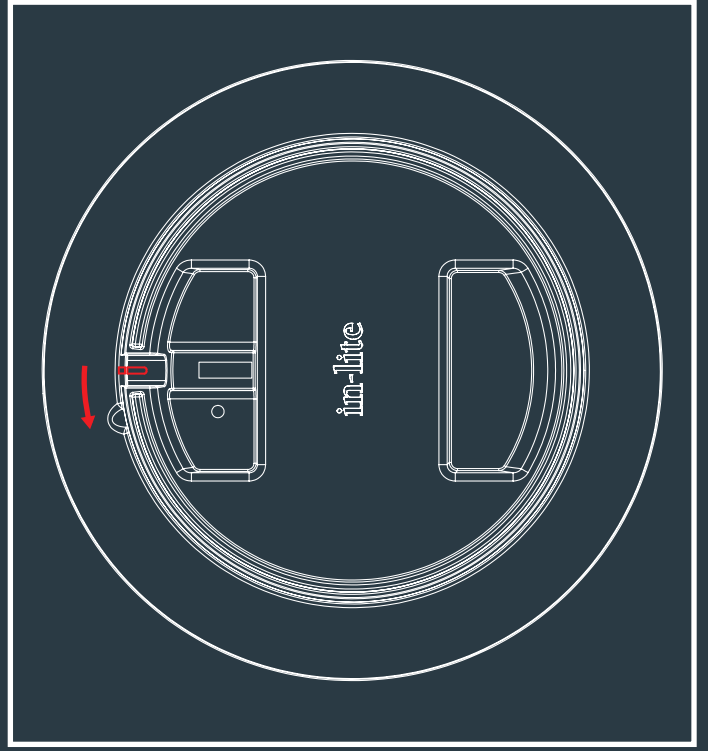
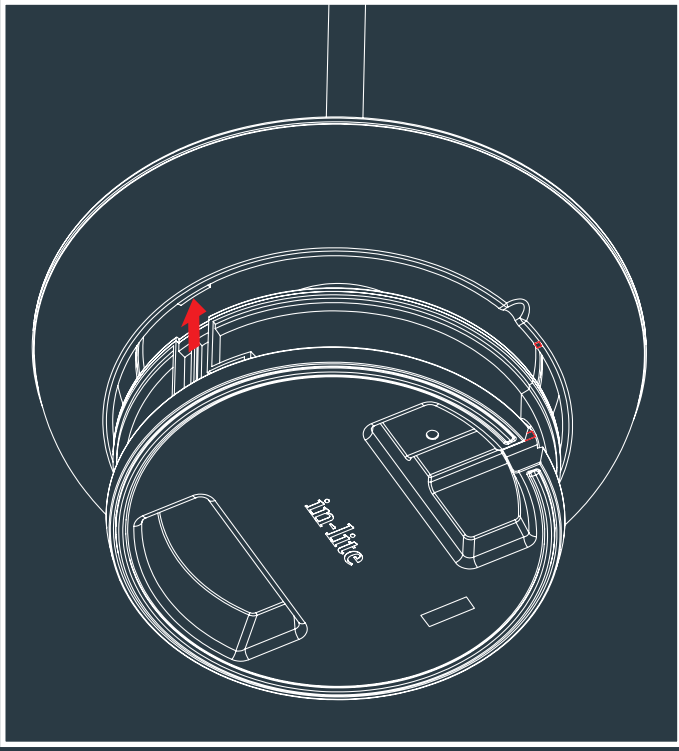

in-lite

USER INFORMATION

This product comes with an corresponding USB charging cable. Use an adapter in combination with this USB cable to charge the lamp (*Adapter max. 5 Volt 1 Amp*). If you charge your product with an adapter that does not meet these conditions, it can affect the life of the battery.

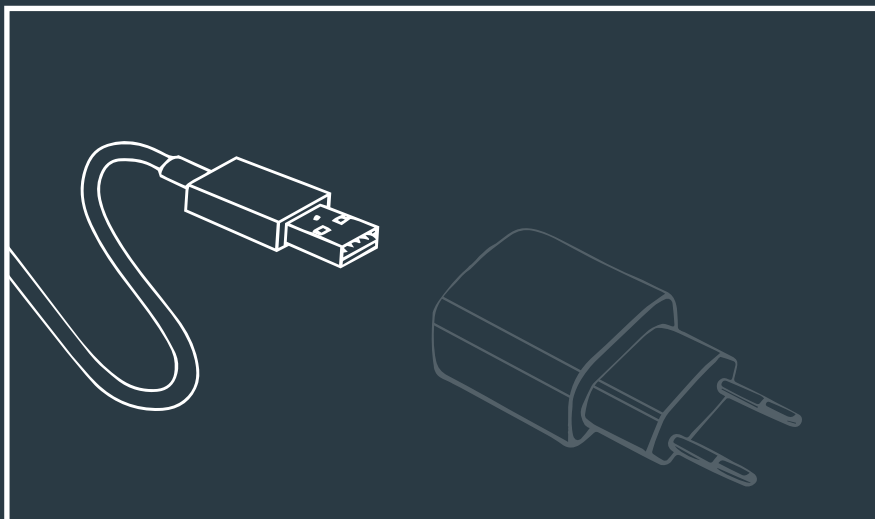

CLEANING INSTRUCTIONS

Clean the surface with a soft (microfiber), damp cloth and wipe with a dry (microfiber) cloth afterwards. Do not use any abrasive cleaning tools and strong cleaning agents, only use liquid soap if needed.



IMPORTANT

The battery must be removed from the lamp before it is scrapped; the appliance must be disconnected from the supply mains when removing the battery; the battery must be disposed seperately so it can be recycled.

In-lite will not take responsibility for accidents or injuries that occur due to incorrect use of battery/LED

in-lite®